



ARCHITECTURAL
HARDWARE



suporte
de vendas

soporte
de ventas



**sales
support**

WWW.JNF.PT

ALWAYS
MORE





**TEMOS UMA DAS MAIS
DESENVOLVIDAS
SOLUÇÕES PARA O
APOIO NAS VENDAS.**

*WE HAVE ONE OF THE
MOST DEVELOPED
SOLUTIONS FOR SALES
SUPPORT.*

*TENEMOS UNA DE
LAS SOLUCIONES MÁS
DESARROLLADAS DE
SOPORTE DE VENTAS.*

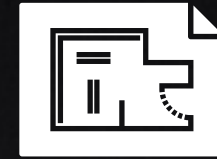

**JNF
STORE**

04 - 11



**JNF
DELTA**

10 - 25

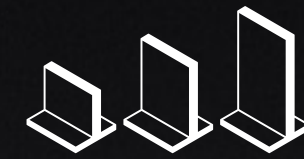

**JNF
ONE
BY ONE**

26 - 35



**JNF
SUITCASES**

36 - 39

Todos os projectos foram desenvolvidos de forma a darem o máximo de informação possível sobre os produtos de forma objectiva clara e rápida.

A linguagem é muito linear e técnica, sendo no entanto facilmente interpretada mesmo por clientes não profissionais.

All projects were developed to give as much information as possible about the products in a fast, clear and objective way.

The language is very linear and technical, and yet easily understood even by non-professional customers.

Todos los proyectos fueron desarrollados para dar la mayor información posible sobre los productos de manera objetiva y rápida.

El lenguaje es muy lineal y técnica, y sin embargo fácil de entender incluso por los clientes no profesionales.

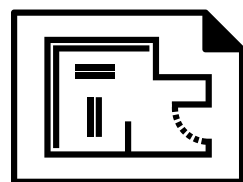

JNF STORE
JNF DELTA
JNF ONE BY ONE
JNF SUITCASES

DECORAÇÃO INTEGRAL DE ESPAÇO COMERCIAL DEDICADO À GAMA JNF.

FULL DECORATION OF
RETAIL SPACE DEDICATED
TO THE JNF RANGE.

DECORACIÓN COMPLETA
DE ESPACIO COMERCIAL
DEDICADO A LA LÍNEA JNF.



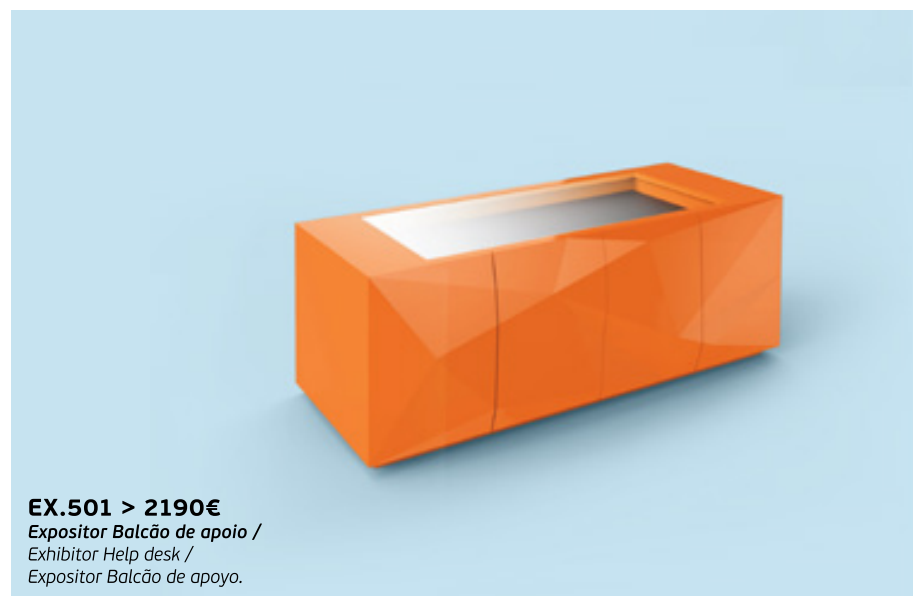
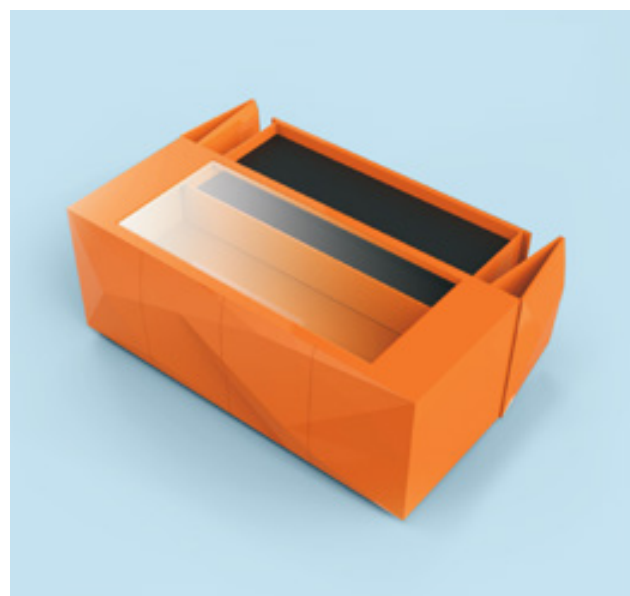

EX.501 > 2190€
Expositor Balcão de apoio /
Exhibitor Help desk /
Expositor Balcão de apoio.



EX.501.A > 900€
Expositor Balcão de apoio /
Exhibitor Help desk /
Expositor Balcão de apoio.

**EXPOSITOR (TIPO 1) - VERSÃO PAREDE**

EXHIBITOR (TYPE 1) - WALL VERSION / EXPOSITOR (TIPO 1) - VERSIÓN MURAL

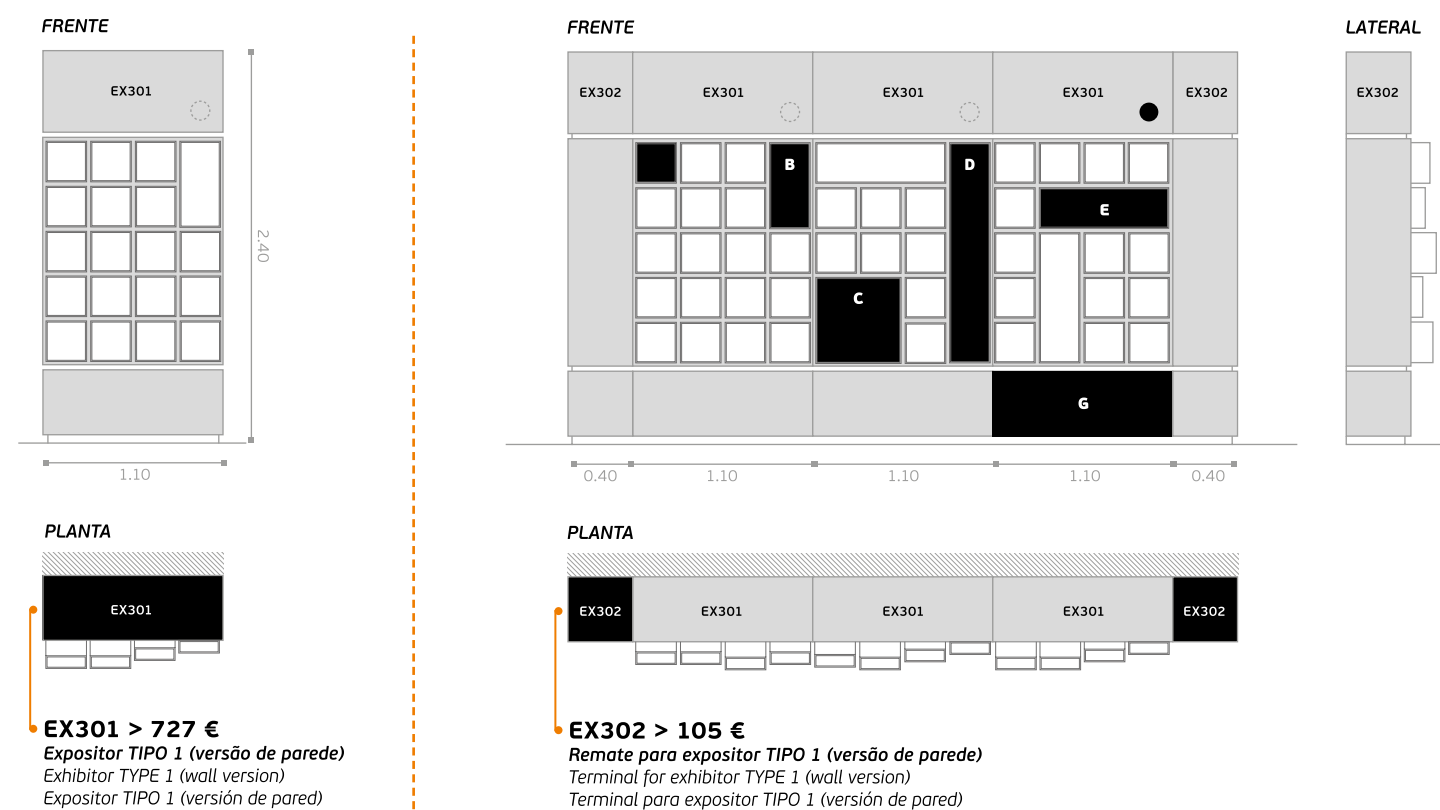
**EXPOSITOR (TIPO 1) - VERSÃO CENTRAL**

EXHIBITOR (TYPE 1) - CENTRAL VERSION / EXPOSITOR (TIPO 1) - VERSIÓN CENTRAL

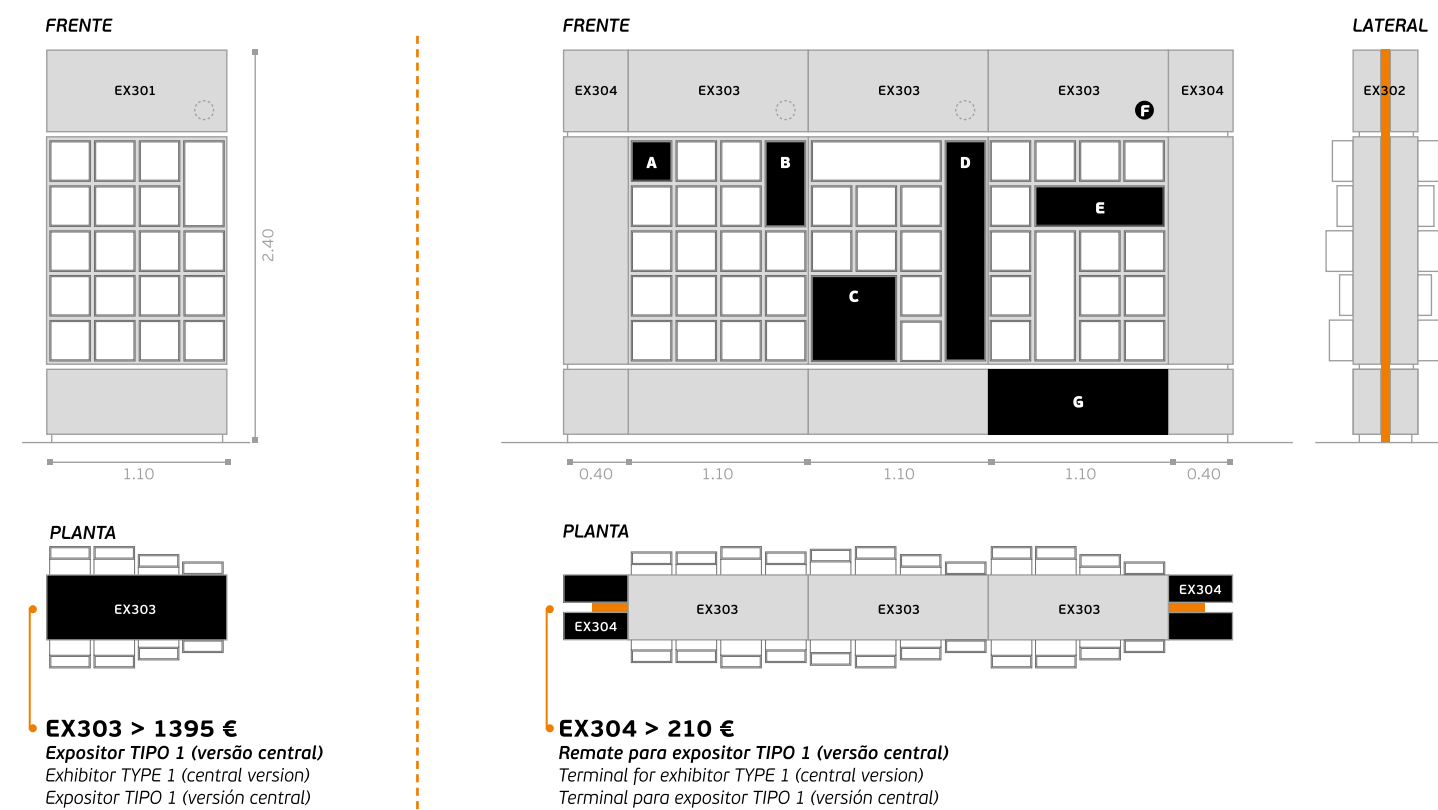
**FORMATO /**
FORMAT / FORMATO:

- A** --- 250 x 250mm
B --- 500 x 300mm
C --- 500 x 500mm
D --- 1250 x 300mm
E --- 750 x 300mm

F

Símbolo representativo do grupo de ferragens /
 Symbol representative of the hardware group /
 Símbolo que representa el grupo de herrajes /

G

Armário para armazenar produtos /
 Closet for storing products /
 Armario para almacenamiento de productos /





JNF STORE
JNF DELTA
JNF ONE BY ONE
JNF SUITCASES

PREENCHIMENTO DE ESPAÇOS COM EXPOSITORES DE FORMAS MODULARES TRIANGULARES.

DECORATION OF SPACES
WITH TRIANGULAR
MODULAR DISPLAYS.

DECORACIÓN DE ESPACIOS
CON EXPOSITORES DE
FORMAS MODULARES
TRIANGULARES.





EXPOSITOR DELTA

EXHIBITOR DELTA / EXPOSITOR DELTA



EXP.100.B > 350€

Expositor DELTA
(fundo preto sem rodas)
Exhibitor DELTA
(black background without wheels)
Expositor DELTA
(fondo negro sin ruedas)

Preço referente ao expositor sem ferragens /
Reference price for exhibitor without hardware /
Precio medio por expositor sin herrajes.



EXP.100.W > 350€

Expositor DELTA
(fundo branco sem rodas)
Exhibitor DELTA
(white background without wheels)
Expositor DELTA
(fondo blanco sin ruedas)

Preço referente ao expositor sem ferragens /
Reference price for exhibitor without hardware /
Precio medio por expositor sin herrajes.



EXP.101.B > 370€ / EXP.101.W > 370€

Expositor DELTA
(fundo branco ou preto com rodas)
Exhibitor DELTA
(white or black background with wheels)
Expositor DELTA
(fondo blanco ou negro con ruedas)

Preço referente ao expositor sem ferragens /
Reference price for exhibitor without hardware /
Precio medio por expositor sin herrajes.

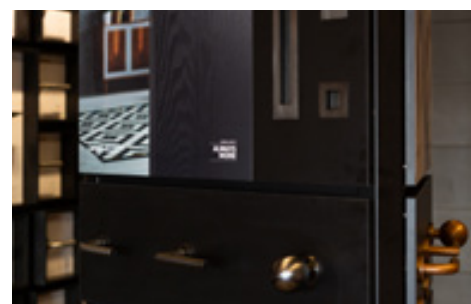
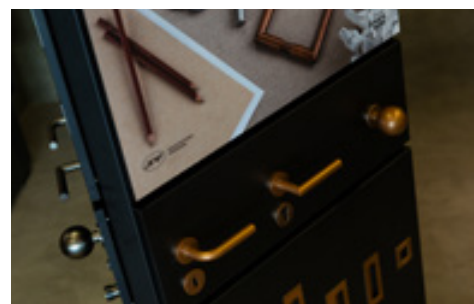

COMO ENCOMENDAR

HOW TO ORDER / COMO PEDIR

1. Escolher o expositor
Choose the exhibitor
Elegir el expositor

2. Escolher as combinações de placas e produtos das 3 fases.
Choose the combinations of boards and products of the 3 panels.
Elegir las combinaciones de placas y productos de las 3 caras.

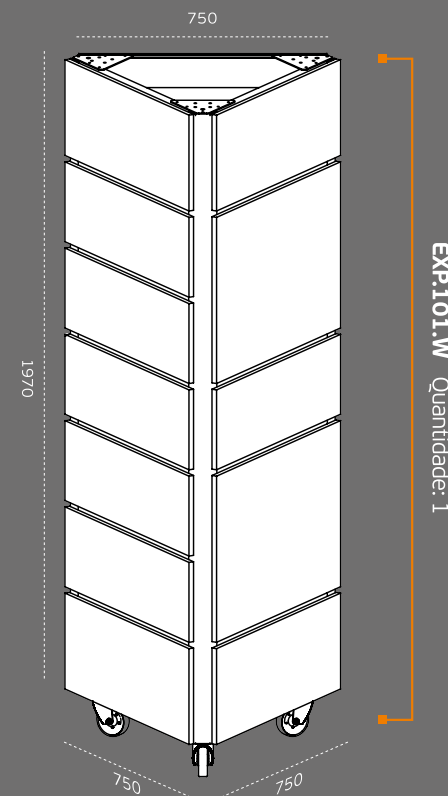

Exemplo: Placa + Referencia de produtos
Example : Board + Product reference
Ejemplo: Placa + Referencia de produto

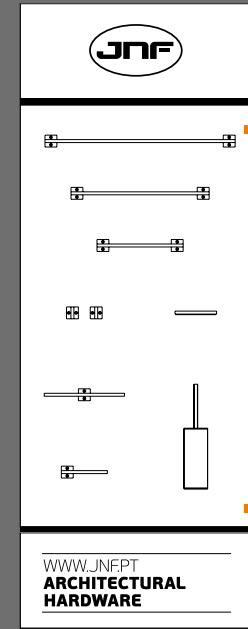
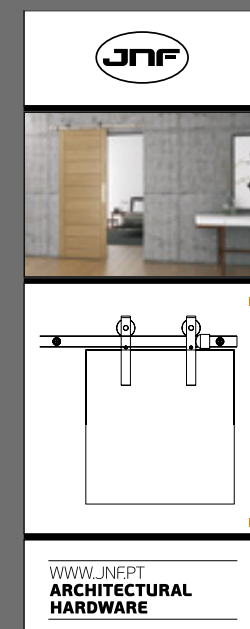
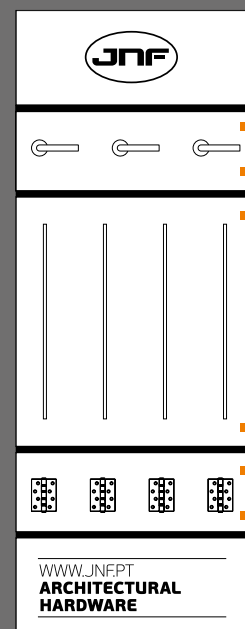

EXP.W03.D
Slim black serie



EXPOSITOR DE PAREDE DELTA - VERSÃO BRANCO

EXHIBITOR DELTA - WALL VERSION / EXPOSITOR DELTA - VERSIÓN MURAL

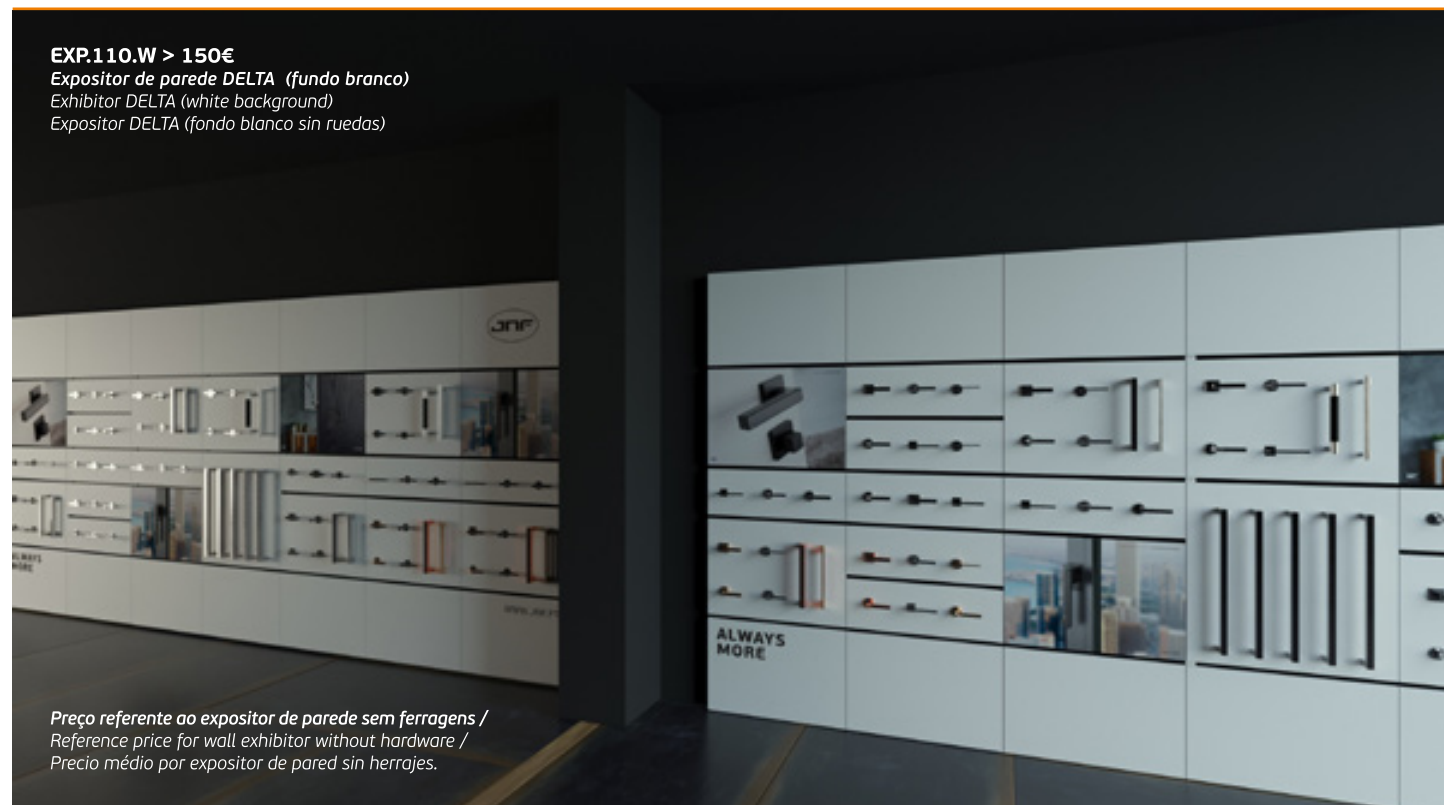

EXP.110.W > 150€
Expositor de parede DELTA (fundo branco)
Exhibitor DELTA (white background)
Expositor DELTA (fondo blanco sin ruedas)

Preço referente ao expositor de parede sem ferragens /
Reference price for wall exhibitor without hardware /
Precio médio por expositor de pared sin herrajes.

EXPOSITOR DELTA - VERSÃO PAREDE

EXHIBITOR DELTA - WALL VERSION / EXPOSITOR DELTA - VERSIÓN MURAL



EXP.110.B > 150€
Expositor de parede DELTA (fundo preto)
Wall exhibitor DELTA (black background)
Expositor de pared DELTA (fondo negro)

Preço referente ao expositor de parede sem ferragens /
Reference price for wall exhibitor without hardware /
Precio médio por expositor de pared sin herrajes.



COMO ENCOMENDAR

HOW TO ORDER / COMO PEDIR

1. Escolher o expositor
Choose the exhibitor
Elegir el expositor

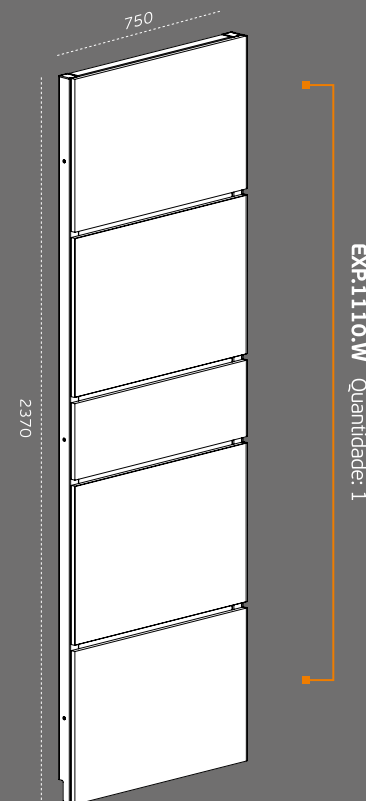

2. Escolher as combinações de placas e produtos das 3 fases.
Choose the combinations of boards and products of the 3 panels.
Elegir las combinaciones de placas y productos de las 3 caras.



Exemplo: Placa + Referencia de produtos
Example : Board + Product reference
Ejemplo: Placa + Referencia de produto





EXPOSITOR DELTA - PLACA 01

EXHIBITOR DELTA - BOARD 01 / EXPOSITOR DELTA - PLACA 01

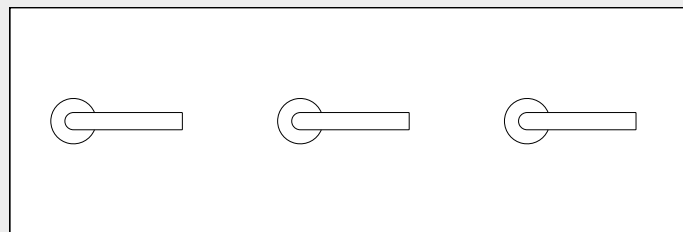

PRETO / BLACK / NEGRO

BRANCO / WHITE / BLANCO

EXP.B01.A

Puxadores e rosetas /
Lever handles and roses /
Manillas y rosetas.

EXP.W01.A

Puxadores e rosetas /
Lever handles and roses /
Manillas y rosetas.

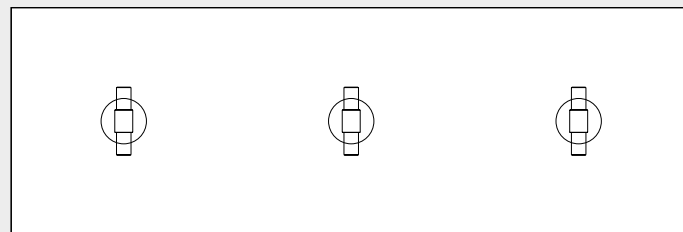

PRETO / BLACK / NEGRO

BRANCO / WHITE / BLANCO

EXP.B01.D

Torniquete e puxador fixo /
Tourniquete and fixed knob /
Torniquete y pomo fijo.

EXP.W01.D

Torniquete e puxador fixo /
Tourniquete and fixed knob /
Torniquete y pomo fijo.

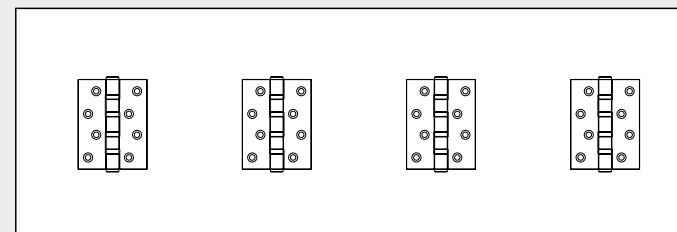

PRETO / BLACK / NEGRO

BRANCO / WHITE / BLANCO

EXP.B01.G

Dobradiças /
Hinges /
Bisagras.

EXP.W01.G

Dobradiças /
Hinges /
Bisagras.

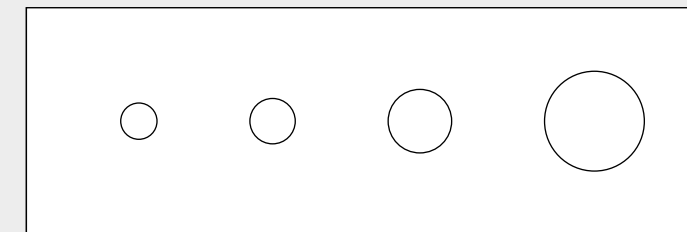

PRETO / BLACK / NEGRO

BRANCO / WHITE / BLANCO

EXP.B01.J

Conchas /
Flush handles /
Cazoletas.

EXP.W01.J

Conchas /
Flush handles /
Cazoletas.

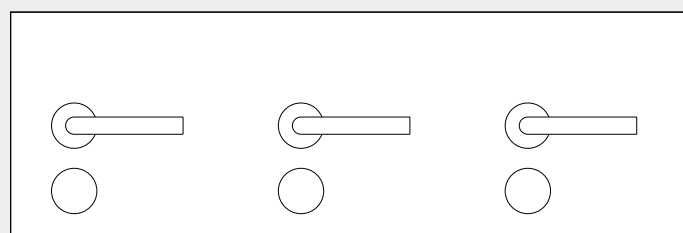

PRETO / BLACK / NEGRO

BRANCO / WHITE / BLANCO

EXP.B01.B

Puxadores e acessórios /
Lever handles and accessories /
Manillas y accesorios.

EXP.W01.B

Puxadores e acessórios /
Lever handles and accessories /
Manillas y accesorios.

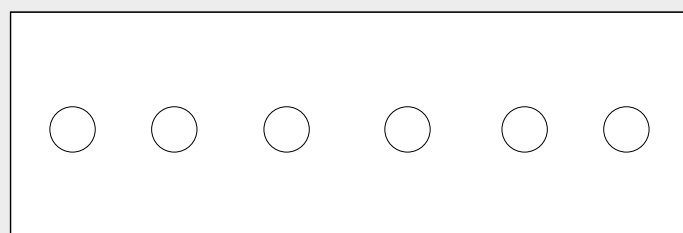

PRETO / BLACK / NEGRO

BRANCO / WHITE / BLANCO

EXP.B01.E

Fecho WC e entrada de chaves /
Snib indicator and key holes /
Condeña de baño y bocallave.

EXP.W01.E

Fecho WC e entrada de chaves /
Snib indicator and key holes /
Condeña de baño y bocallave.

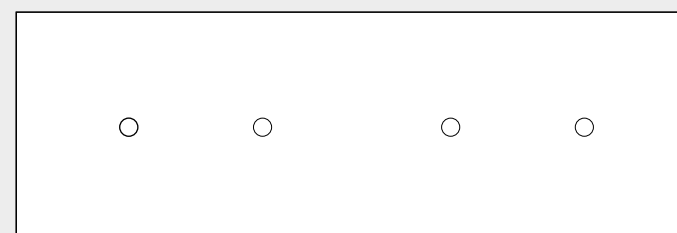

PRETO / BLACK / NEGRO

BRANCO / WHITE / BLANCO

EXP.B01.H

Cabides /
Hook /
Percha.

EXP.W01.H

Cabides /
Hook /
Percha.

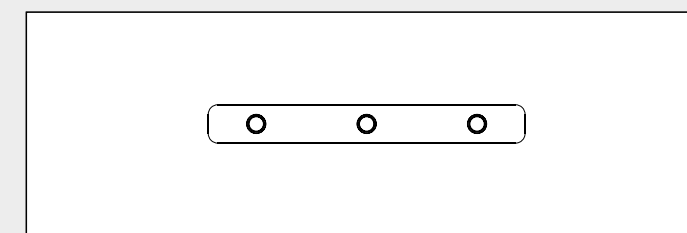

PRETO / BLACK / NEGRO

BRANCO / WHITE / BLANCO

EXP.B01.K

Cabide tripla /
Triple wall hook /
Percha tripla.

EXP.W01.K

Cabide tripla /
Triple wall hook /
Percha tripla.

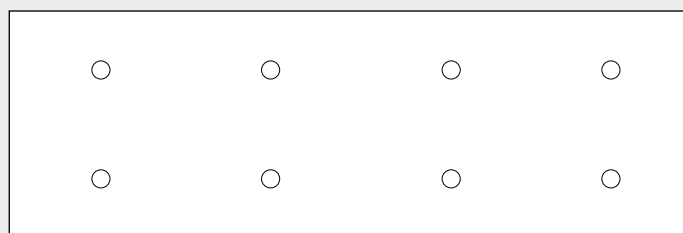

PRETO / BLACK / NEGRO

BRANCO / WHITE / BLANCO

EXP.B01.C

Batentes e puxadores de móvel /
Door stoppers and furniture
hardware /
Topes de puerta y pomo de mueble.

EXP.W01.C

Batentes e puxadores de móvel /
Door stoppers and furniture
hardware /
Topes de puerta y pomo de mueble.

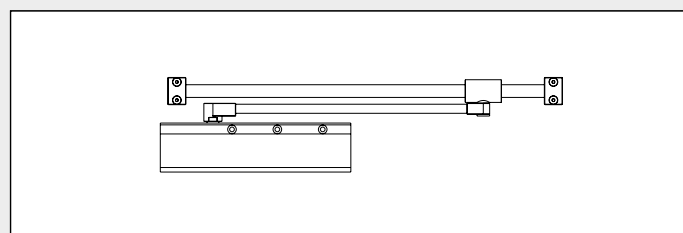

PRETO / BLACK / NEGRO

BRANCO / WHITE / BLANCO

EXP.B01.F

Molas aéreas /
Overhead door closers /
Cierra puertas aéreo.

EXP.W01.F

Molas aéreas /
Overhead door closers /
Cierra puertas aéreas.

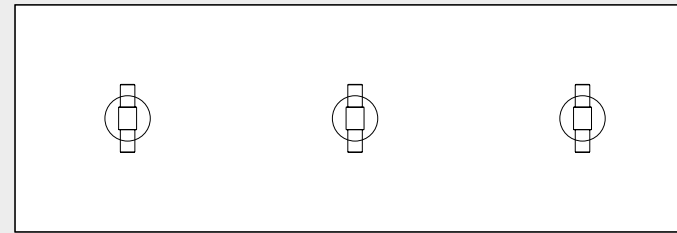

PRETO / BLACK / NEGRO

BRANCO / WHITE / BLANCO

EXP.B01.I

Cremona de janela, suportes de
corrimão e cilindros /
Dk mechanism, handrail support and
cylinders /
Cremona de ventana, soporte de
pasamanos y bombillos.

EXP.W01.I

Cremona de janela, suportes de
corrimão e cilindros /
Dk mechanism, handrail support and
cylinders /
Cremona de ventana, soporte de
pasamanos y bombillos.

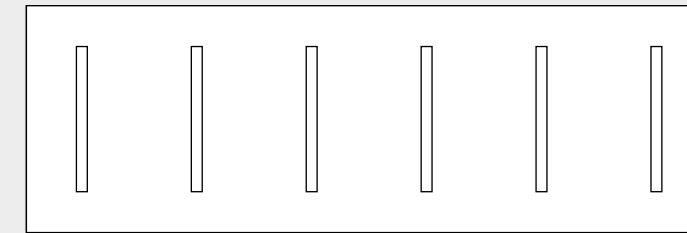

PRETO / BLACK / NEGRO

BRANCO / WHITE / BLANCO

EXP.B01.L

Asas de móvel /
Furniture pull handles /
Tiradores de mueble.

EXP.W01.L

Asas de móvel /
Furniture pull handles /
Tiradores de mueble.



EXPOSITOR DELTA - PLACA 02

EXHIBITOR DELTA - BOARD 02 / EXPOSITOR DELTA - PLACA 02

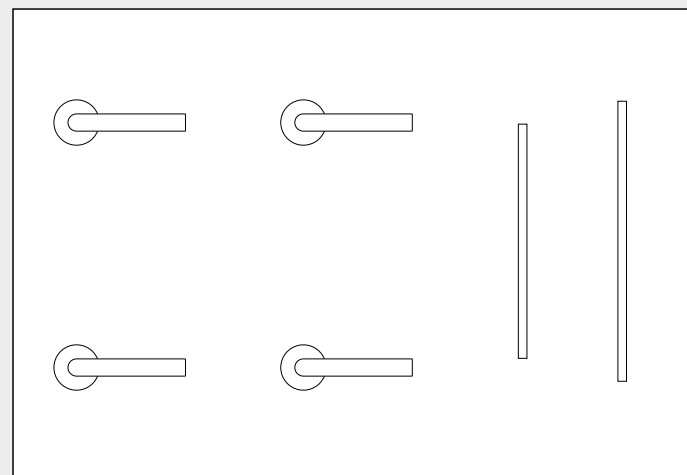

PRETO / BLACK / NEGRO

BRANCO / WHITE / BLANCO

EXP.B02.A

Puxadores e asas /
Lever handles and pull handles /
Manillas y manillones.

EXP.W02.A

Puxadores e asas /
Lever handles and pull handles /
Manillas y manillones.

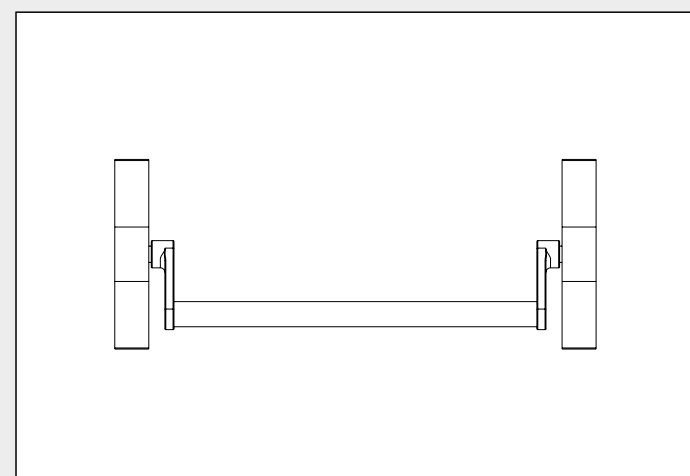

PRETO / BLACK / NEGRO

BRANCO / WHITE / BLANCO

EXP.B02.B

Barra anti-pânico /
Panic exit devices /
Dispositivos antipánico.

EXP.W02.B

Barra anti-pânico /
Panic exit devices /
Dispositivos antipánico.

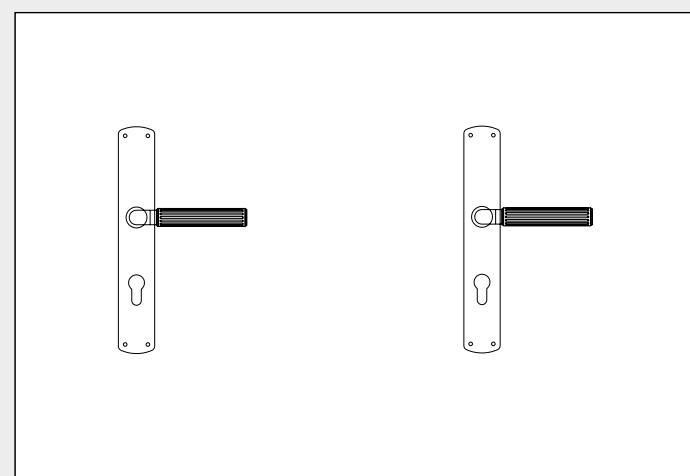

PRETO / BLACK / NEGRO

BRANCO / WHITE / BLANCO

EXP.B02.C

Puxadores e placa /
Lever handles and plates /
Manillas y placas.

EXP.W02.C

Puxadores e placa /
Lever handles and plates /
Manillas y placas.

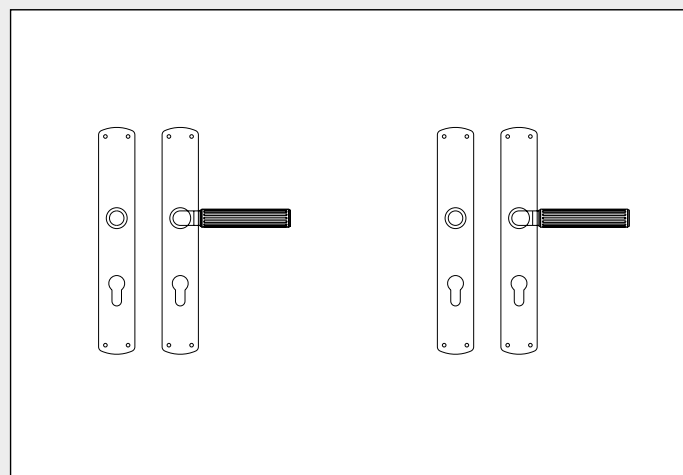

PRETO / BLACK / NEGRO

BRANCO / WHITE / BLANCO

EXP.B02.D

Placas de segurança /
Security plates /
Placas de seguridad.

EXP.W02.D

Placas de segurança /
Security plates /
Placas de seguridad.

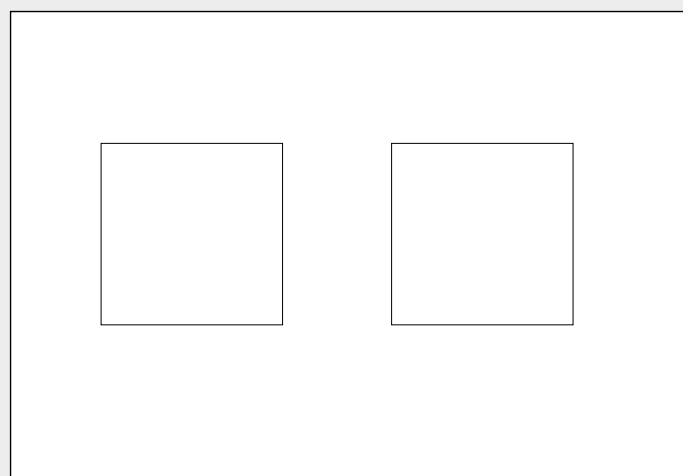

PRETO / BLACK / NEGRO

BRANCO / WHITE / BLANCO

EXP.B02.E

Conchas /
Flush handles /
Cazoletas.

EXP.W02.E

Conchas /
Flush handles /
Cazoletas.

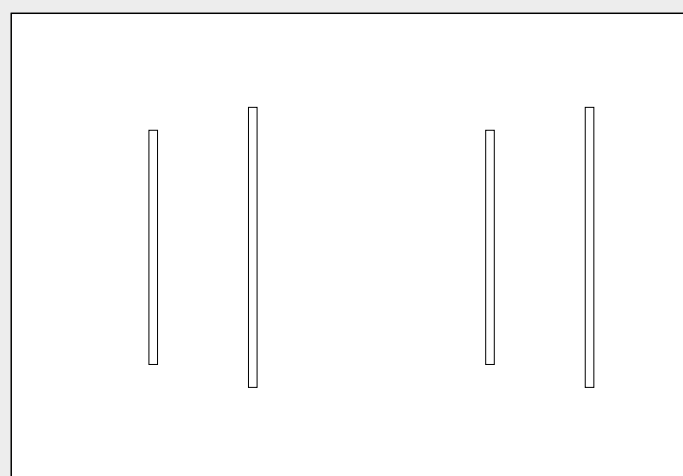

PRETO / BLACK / NEGRO

BRANCO / WHITE / BLANCO

EXP.B02.F

Asas (150mm / 400mm) /
Pull handles (150mm / 400mm) /
Manillones (150mm / 400mm).

EXP.W02.F

Asas (150mm / 400mm) /
Pull handles (150mm / 400mm) /
Manillones (150mm / 400mm).



PRETO / BLACK / NEGRO

BRANCO / WHITE / BLANCO

EXP.B02.G

Imagem fotográfica /
Photo image /
Imagen fotográfica.

EXP.W02.G

Imagem fotográfica /
Photo image /
Imagen fotográfica.

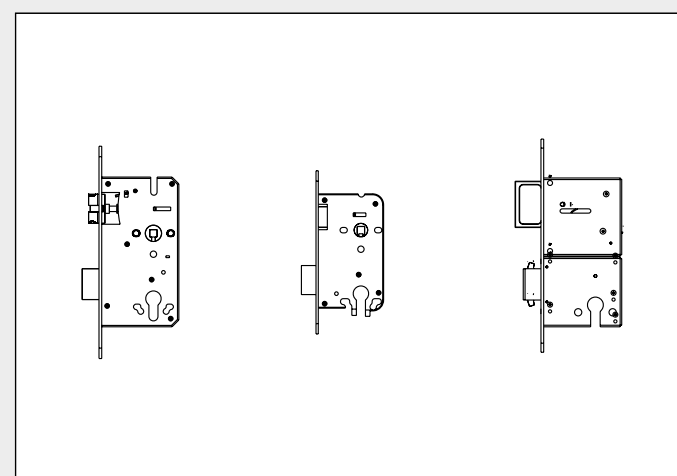

PRETO / BLACK / NEGRO

BRANCO / WHITE / BLANCO

EXP.B02.H

Fechaduras /
Locks /
Cerraduras.

EXP.W02.H

Fechaduras /
Locks /
Cerraduras.

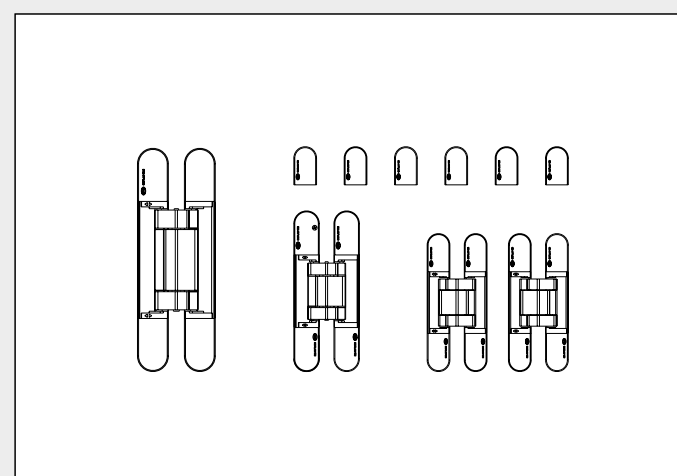

PRETO / BLACK / NEGRO

BRANCO / WHITE / BLANCO

EXP.B02.I

Dobradiças 3D /
3D hinges /
Bisagras 3D.

EXP.W02.I

Dobradiças 3D /
3D hinges /
Bisagras 3D.

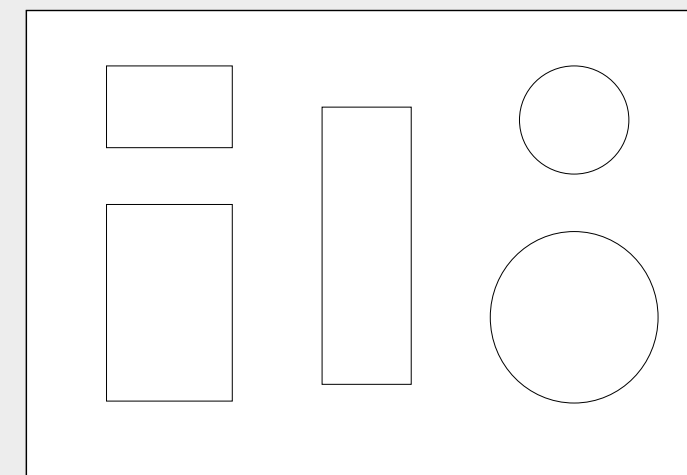

PRETO / BLACK / NEGRO

BRANCO / WHITE / BLANCO

EXP.B02.J

Puxadores fixos /
Fixed knobs /
Pomos fijos.

EXP.W02.J

Puxadores fixos /
Fixed knobs /
Pomos fijos.

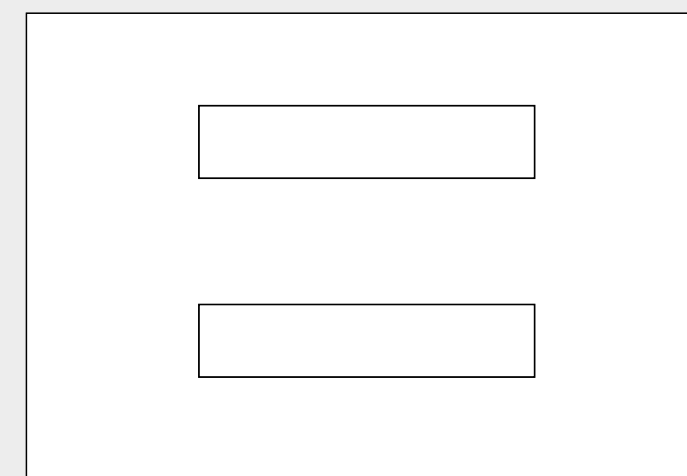

PRETO / BLACK / NEGRO

BRANCO / WHITE / BLANCO

EXP.B02.K

Frentes de correio, ventiladores e
sinalética /
Letter plate, ventilator and
pictograms /
Frente de correio, rejilla y señalética.

EXP.W02.K

Frentes de correio, ventiladores e
sinalética /
Letter plate, ventilator and
pictograms /
Frente de correio, rejilla y señalética.



EXPOSITOR DELTA - PLACA 03

EXHIBITOR DELTA - BOARD 03 / EXPOSITOR DELTA - PLACA 03

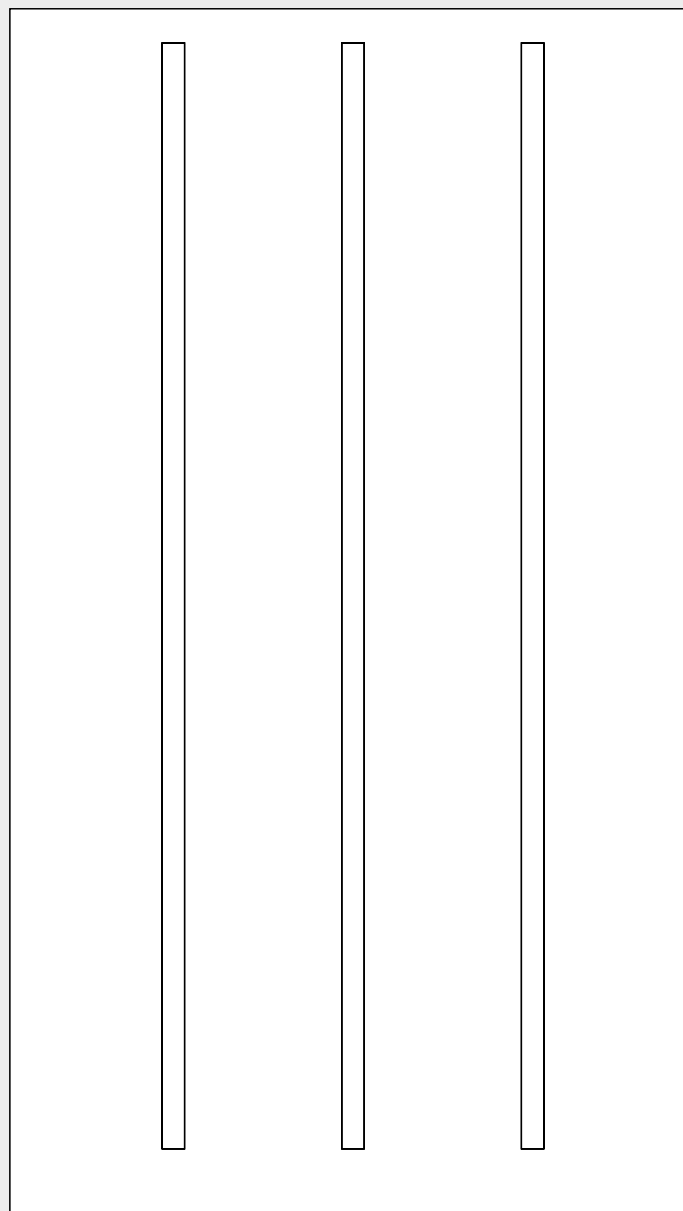

PRETO / BLACK / NEGRO

BRANCO / WHITE / BLANCO

EXP.B03.A

Asas (600mm / 1200mm) /
Pull handles (600mm / 1200mm) /
Manillones (600mm / 1200mm).

EXP.W03.A

Asas (600mm / 1200mm) /
Pull handles (600mm / 1200mm) /
Manillones (600mm / 1200mm).

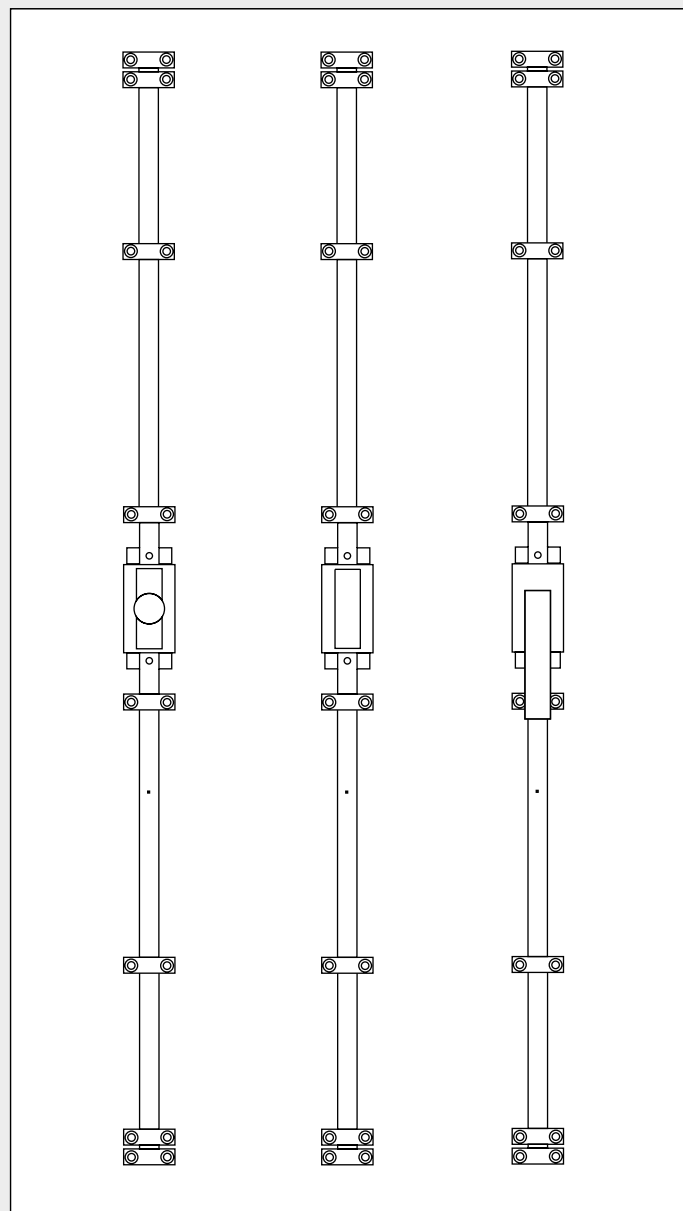

PRETO / BLACK / NEGRO

BRANCO / WHITE / BLANCO

EXP.B03.B

Mecanismo de cremone /
Latch mechanism /
Mecanismo de cremona.

EXP.W03.B

Mecanismo de cremone /
Latch mechanism /
Mecanismo de cremona.

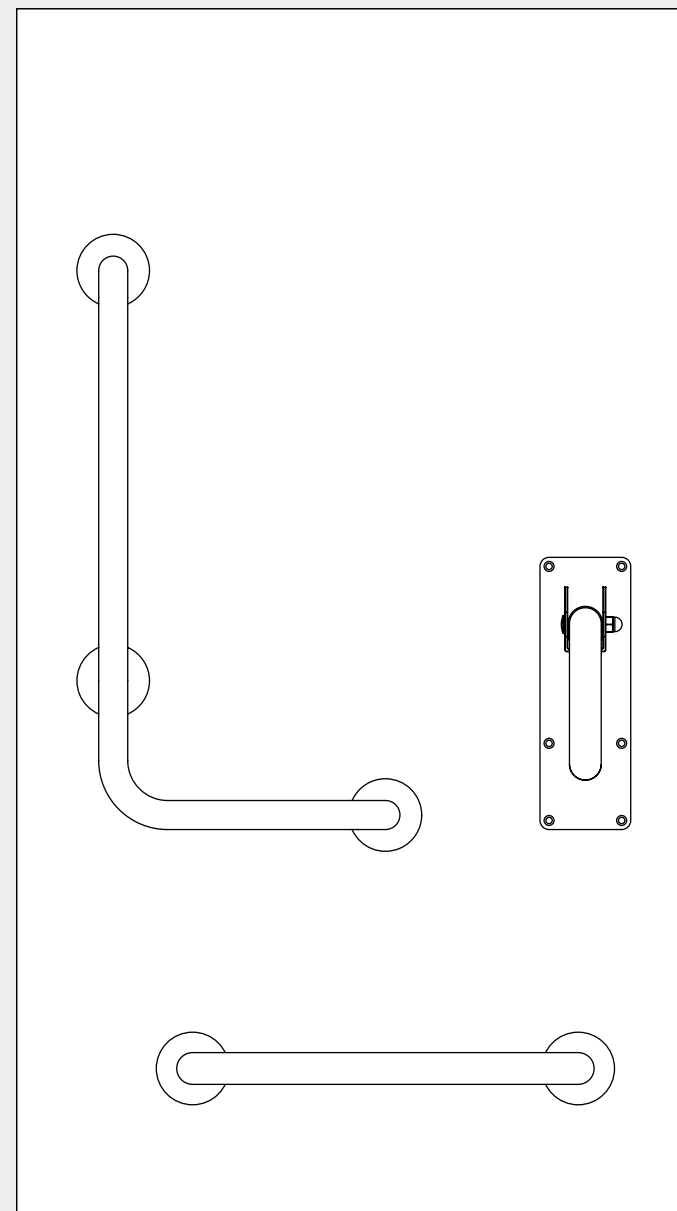

PRETO / BLACK / NEGRO

BRANCO / WHITE / BLANCO

EXP.B03.C

Barra de apoio /
Folding safety support /
Barra de apoio abatível.

EXP.W03.C

Barra de apoio /
Folding safety support /
Barra de apoio abatível.

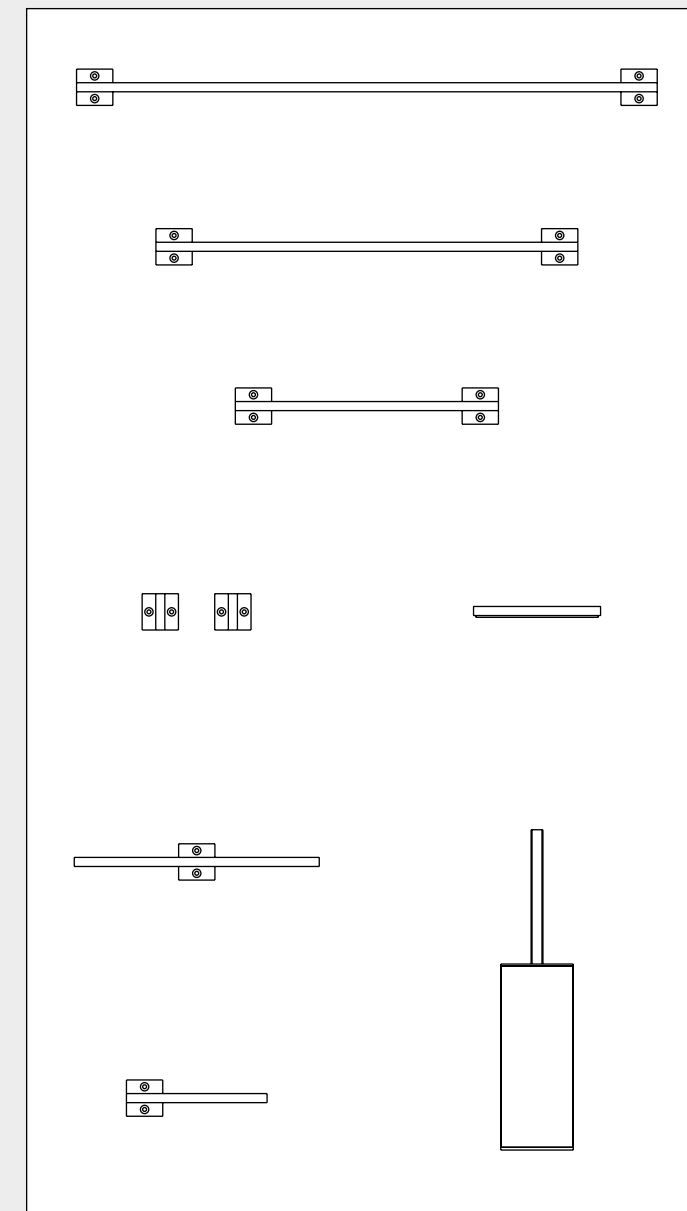

PRETO / BLACK / NEGRO

BRANCO / WHITE / BLANCO

EXP.B03.D

Soluções casa de banho
(Slim Black) /
Bathroom solutions (Slim Black) /
Soluciones de baño (Slim Black).

EXP.W03.D

Soluções casa de banho
(Slim Black) /
Bathroom solutions (Slim Black) /
Soluciones de baño (Slim Black).



EXPOSITOR DELTA - PLACA 03

EXHIBITOR DELTA - BOARD 03 / EXPOSITOR DELTA - PLACA 03

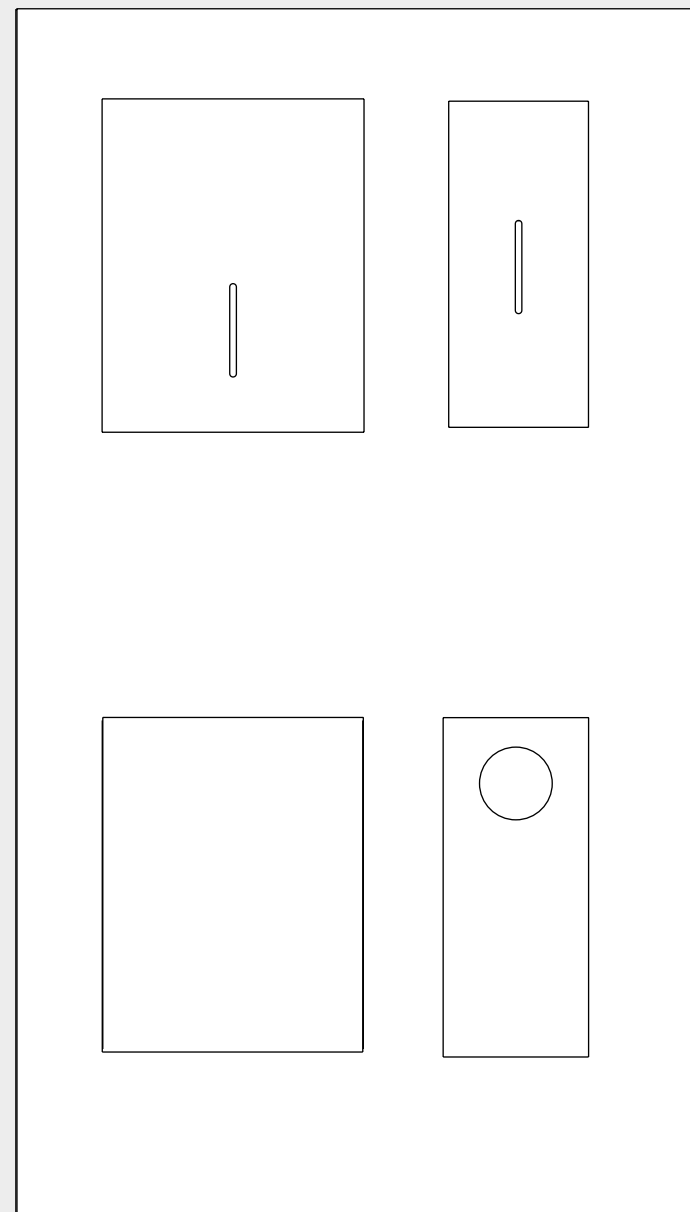

PRETO / BLACK / NEGRO

BRANCO / WHITE / BLANCO

EXP.B03.E
Serie industrial /
Industrial series /
Serie industrial.

EXP.W03.E
Serie industrial /
Industrial series /
Serie industrial.

EXPOSITOR DELTA - PLACA 04

EXHIBITOR DELTA - BOARD 04 / EXPOSITOR DELTA - PLACA 04

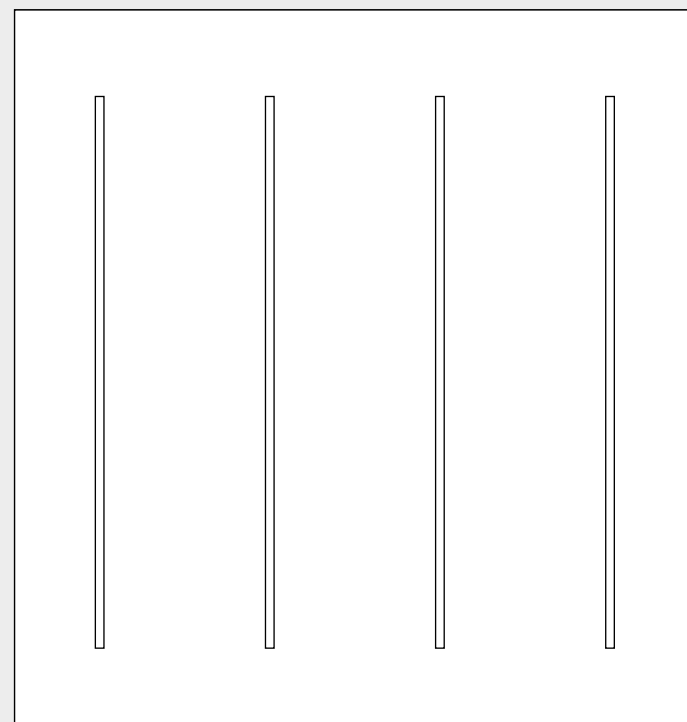

PRETO / BLACK / NEGRO

BRANCO / WHITE / BLANCO

EXP.B04.A
Asas (máx. 600mm) /
Pull handles (máx. 600mm) /
Manillones (máx. 600mm).

EXP.W04.A
Asas (máx. 600mm) /
Pull handles (máx. 600mm) /
Manillones (máx. 600mm).

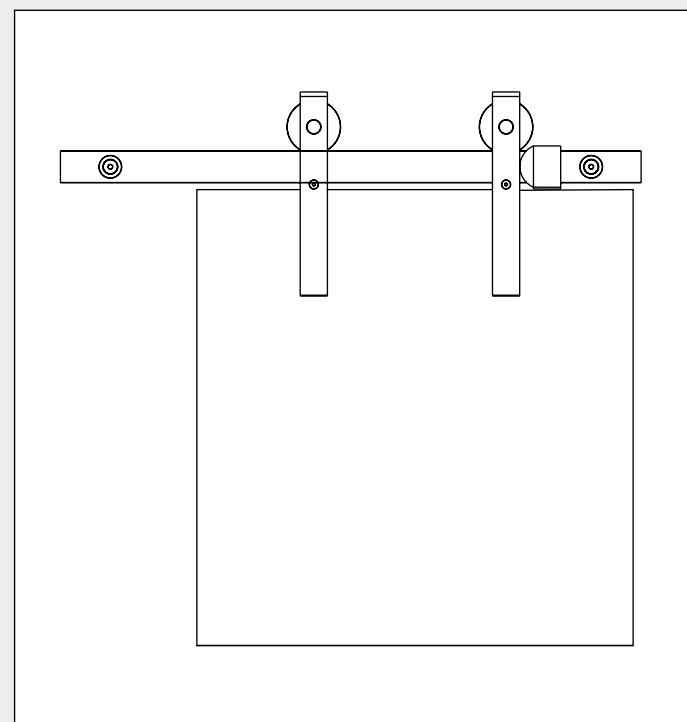

PRETO / BLACK / NEGRO

BRANCO / WHITE / BLANCO

EXP.B04.B
Portas de correr /
Sliding doors /
Puertas correderas.

EXP.W04.B
Portas de correr /
Sliding doors /
Puertas correderas.



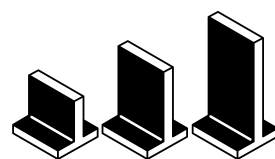

JNF STORE
JNF DELTA
JNF ONE BY ONE
JNF SUITCASES

EXPOSITORES INDIVIDUALIZADOS PARA CADA LINHA DE FERRAGENS JNF.

EXHIBITORS
INDIVIDUALIZED
FOR EACH LINE OF
HARDWARE.

EXPOSITORES
INDIVIDUALIZADOS
PARA CADA LÍNIA DE
HERRAJE.





EX.513 > 21,00€

Preço referente ao expositor sem ferragens /
Reference price for exhibitor without hardware /
Precio medio por expositor sin herrajes.



EX.514 > 21,00€

Preço referente ao expositor sem ferragens /
Reference price for exhibitor without hardware /
Precio medio por expositor sin herrajes.



EX.513 > 21,00€

Preço referente ao expositor sem ferragens /
Reference price for exhibitor without hardware /
Precio medio por expositor sin herrajes.



EX.515 > 21,00€

Preço referente ao expositor sem ferragens /
Reference price for exhibitor without hardware /
Precio medio por expositor sin herrajes.



EX.510 > 16,00€

Preço referente ao expositor sem ferragens /
Reference price for exhibitor without hardware /
Precio medio por expositor sin herrajes.



EX.511 > 16,00€

Preço referente ao expositor sem ferragens /
Reference price for exhibitor without hardware /
Precio medio por expositor sin herrajes.



EX.512 > 16,00€

Preço referente ao expositor sem ferragens /
Reference price for exhibitor without hardware /
Precio medio por expositor sin herrajes.





EX.505 > 36,50€
Preço referente ao expositor sem ferragens /
Reference price for exhibitor without hardware /
Precio medio por expositor sin herrajes.

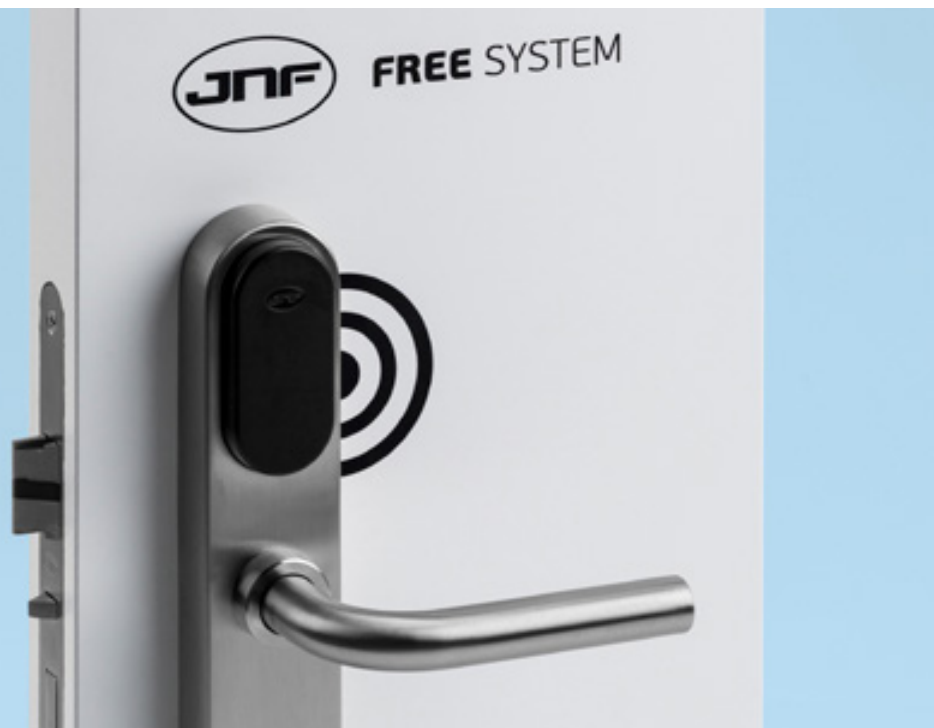

EX.508 > 36,50€
Preço referente ao expositor sem ferragens /
Reference price for exhibitor without hardware /
Precio medio por expositor sin herrajes.





EX.506 > 36,50€
 Preço referente ao expositor sem ferragens /
 Reference price for exhibitor without hardware /
 Precio medio por expositor sin herrajes.





EX.522 > 15,50€

Preço referente ao expositor sem ferragens /
Reference price for exhibitor without hardware /
Precio medio por expositor sin herrajes.



EX.521 > 17,00€

Preço referente ao expositor sem ferragens /
Reference price for exhibitor without hardware /
Precio medio por expositor sin herrajes.



EX.522 > 15,50€

Preço referente ao expositor sem ferragens /
Reference price for exhibitor without hardware /
Precio medio por expositor sin herrajes.



EX.521 > 17,00€

Preço referente ao expositor sem ferragens /
Reference price for exhibitor without hardware /
Precio medio por expositor sin herrajes.



EX.520 > 18,50€

Preço referente ao expositor sem ferragens /
Reference price for exhibitor without hardware /
Precio medio por expositor sin herrajes.



EX.520 > 18,50€

Preço referente ao expositor sem ferragens /
Reference price for exhibitor without hardware /
Precio medio por expositor sin herrajes.

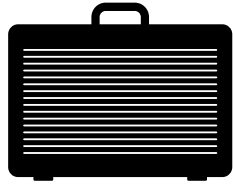

JNF STORE
JNF DELTA
JNF ONE BY ONE
JNF SUITCASES

MALAS INDIVIDUALIZADAS PARA CADA LINHA DE FERRAGENS JNF.

SUITCASES
INDIVIDUALIZED FOR
EACH LINE OF HARDWARE.

MALETAS
INDIVIDUALIZADAS PARA
CADA LÍNEA DE HERRAJE.





EX.020

EX.021

EX.022

EX.023



EX.024

EX.025

EX.026

EX.027



EX.028

EX.029

EX.030

EX.020
EXPOSITOR - FERRAGENS PARA VIDRO /
DISPLAY - GLASS HARDWARE / EXPOSITOR - HERRAJES PARA CRISTAL

EXPOSITOR - FERRAGENS PARA VIDRO /
DISPLAY - GLASS HARDWARE / EXPOSITOR - HERRAJES PARA CRISTAL

www.jnf.pt

EX.021
EXPOSITOR - FERRAGENS PARA VIDRO /
DISPLAY - GLASS HARDWARE / EXPOSITOR - HERRAJES PARA CRISTAL

EXPOSITOR - FERRAGENS PARA VIDRO /
DISPLAY - GLASS HARDWARE / EXPOSITOR - HERRAJES PARA CRISTAL

www.jnf.pt

EX.022
EXPOSITOR - SISTEMAS DE CONTROLO DE ACESSOS /
DISPLAY - ACCESS CONTROL SYSTEMS / EXPOSITOR - SISTEMAS DE CONTROL DE ACCESOS

EXPOSITOR - SISTEMAS DE CONTROLO DE ACESSOS /
DISPLAY - ACCESS CONTROL SYSTEMS / EXPOSITOR - SISTEMAS DE CONTROL DE ACCESOS

www.jnf.pt

EX.023
EXPOSITOR - SISTEMAS DE PORTA DE CORRER 020 mm /
DISPLAY - SLIDING DOOR SYSTEMS / EXPOSITOR - SISTEMAS PARA PUERTAS CORREDIZAS 020 mm

EXPOSITOR - SISTEMAS DE PORTA DE CORRER 020 mm /
DISPLAY - SLIDING DOOR SYSTEMS / EXPOSITOR - SISTEMAS PARA PUERTAS CORREDIZAS 020 mm

www.jnf.pt

EX.024
EXPOSITOR - SISTEMAS DE PORTA DE CORRER 025 mm /
DISPLAY - SLIDING DOOR SYSTEMS / EXPOSITOR - SISTEMAS PARA PUERTAS CORREDIZAS 025 mm

EXPOSITOR - SISTEMAS DE PORTA DE CORRER 025 mm /
DISPLAY - SLIDING DOOR SYSTEMS / EXPOSITOR - SISTEMAS PARA PUERTAS CORREDIZAS 025 mm

www.jnf.pt

EX.025
EXPOSITOR - FERRAGENS PARA PORTAS E ACESSÓRIOS /
DISPLAY - LEVER HANDLES, PULL HANDLES AND ACCESSORIES /
EXPOSITOR - MANILLAS, MANILLONES DE PUERTA Y ACCESÓRIOS

EXPOSITOR - FERRAGENS PARA PORTAS E ACESSÓRIOS /
DISPLAY - LEVER HANDLES, PULL HANDLES AND ACCESSORIES /
EXPOSITOR - MANILLAS, MANILLONES DE PUERTA Y ACCESÓRIOS

www.jnf.pt

EX.026
EXPOSITOR - FERRAGENS PARA VIDRO /
DISPLAY - GLASS HARDWARE / EXPOSITOR - HERRAJES PARA CRISTAL

EXPOSITOR - FERRAGENS PARA VIDRO /
DISPLAY - GLASS HARDWARE / EXPOSITOR - HERRAJES PARA CRISTAL

www.jnf.pt

EX.027
EXPOSITOR - FERRAGENS PARA VIDRO /
DISPLAY - GLASS HARDWARE / EXPOSITOR - HERRAJES PARA CRISTAL

EXPOSITOR - FERRAGENS PARA VIDRO /
DISPLAY - GLASS HARDWARE / EXPOSITOR - HERRAJES PARA CRISTAL

www.jnf.pt

EX.028
EXPOSITOR - SISTEMAS MODULARES /
DISPLAY - MODULAR SYSTEMS / EXPOSITOR - SISTEMAS MODULARES

EXPOSITOR - SISTEMAS MODULARES /
DISPLAY - MODULAR SYSTEMS / EXPOSITOR - SISTEMAS MODULARES

www.jnf.pt

EX.029
EXPOSITOR - MAN COLUMNS /
DISPLAY - MAN COLUMNS / EXPOSITOR - MAN COLUMNAS

EXPOSITOR - MAN COLUMNS /
DISPLAY - MAN COLUMNS / EXPOSITOR - MAN COLUMNAS

www.jnf.pt

EX.030
EXPOSITOR - SISTEMAS MODULARES DE CUBOS /
DISPLAY - MODULAR SYSTEMS OF CUBES / EXPOSITOR - SISTEMAS MODULARES DE CUBOS

EXPOSITOR - SISTEMAS MODULARES DE CUBOS /
DISPLAY - MODULAR SYSTEMS OF CUBES / EXPOSITOR - SISTEMAS MODULARES DE CUBOS

www.jnf.pt

EX.0... > 32,50 €
Preço referente à mala com espuma sem ferragens /
Reference price for suitcase with foam without hardware /
Precio medio por maleta con espuma sin herrajes.





**ARCHITECTURAL
HARDWARE**



JNF PORTUGAL

Head office / Factory

Comércio e Indústria de Ferragens S.A.
Rua Mimosas 849/851,
Zona Industrial Mimosas
S. Pedro da Cova | Apartado 75
4424-909 Gondomar, Portugal

Tel: +351 224 663 230

jnf@jnf.pt

www.jnf.pt

JNF PORTUGAL

ATP / Showroom

Av. da Boavista, 3523-5º
Sala 501
Porto, Portugal

Tel: +351 226 168 249

dulce.neves@jnf.pt

www.jnf.pt

JNF SOUTH AMERICA

Office

Rinconada el Salto, 1000,
Comuna Huechuraba
8580000 - Santiago de Chile

Tel: +562 3291 7482

manuel.simao@jnf.cl

Tlm: +569 9440 9330

jnf@jnf.cl

www.jnf.cl

JNF SPAIN

Office / Showroom

JNFmyStore
Carrer Bruc, 77 Local dch.
08009 Barcelona

Tel: +34 932 504 047

Fax: +34 934 674 500

jnf@jnfmystore.es

www.jnfmystore.es

JNF ASIA

Office / Showroom

Room A5, 7/F, Block A, Mai Hing Industrial
Building, 16-18 Hing Yip Street, Kwun Tong,
Kowloon, Hong Kong

Tel : +852 3460 4031

Fax : +852 3013 9765

jnf@sava.hk

www.jnf.hk

AS ESPECIFICAÇÕES DOS PRODUTOS CONTIDOS NESTES CATÁLOGOS PODEM SER ALTERADOS SEM AVISO PRÉVIO.

The technical specifications of the products
contents in this catalogue can be changed without
any previous advise.

Las especificaciones técnicas de los productos
contenidos en este catalogo pueden ser
cambiadas sin previo aviso.

A REPRODUÇÃO INTEGRAL OU PARCIAL DESTE CATÁLOGO NÃO É PERMITIDA.

The integral or partial copy of this catalogue is
not allowed. La copia integral o parcial deste
catalogo no es permitida.

**O PRESENTE CATÁLOGO NÃO SEGUIE AS
REGRAS DO NOVO ACORDO ORTOGRÁFICO.**

CT-19.01.3

WWW.JNF.PT



**ALWAYS
MORE**